

Carl's Place

Carl's (4:3) 8x10.5 Ft -- 151in Diagonal Hanging DIY Projector Screen Kit (Portable)

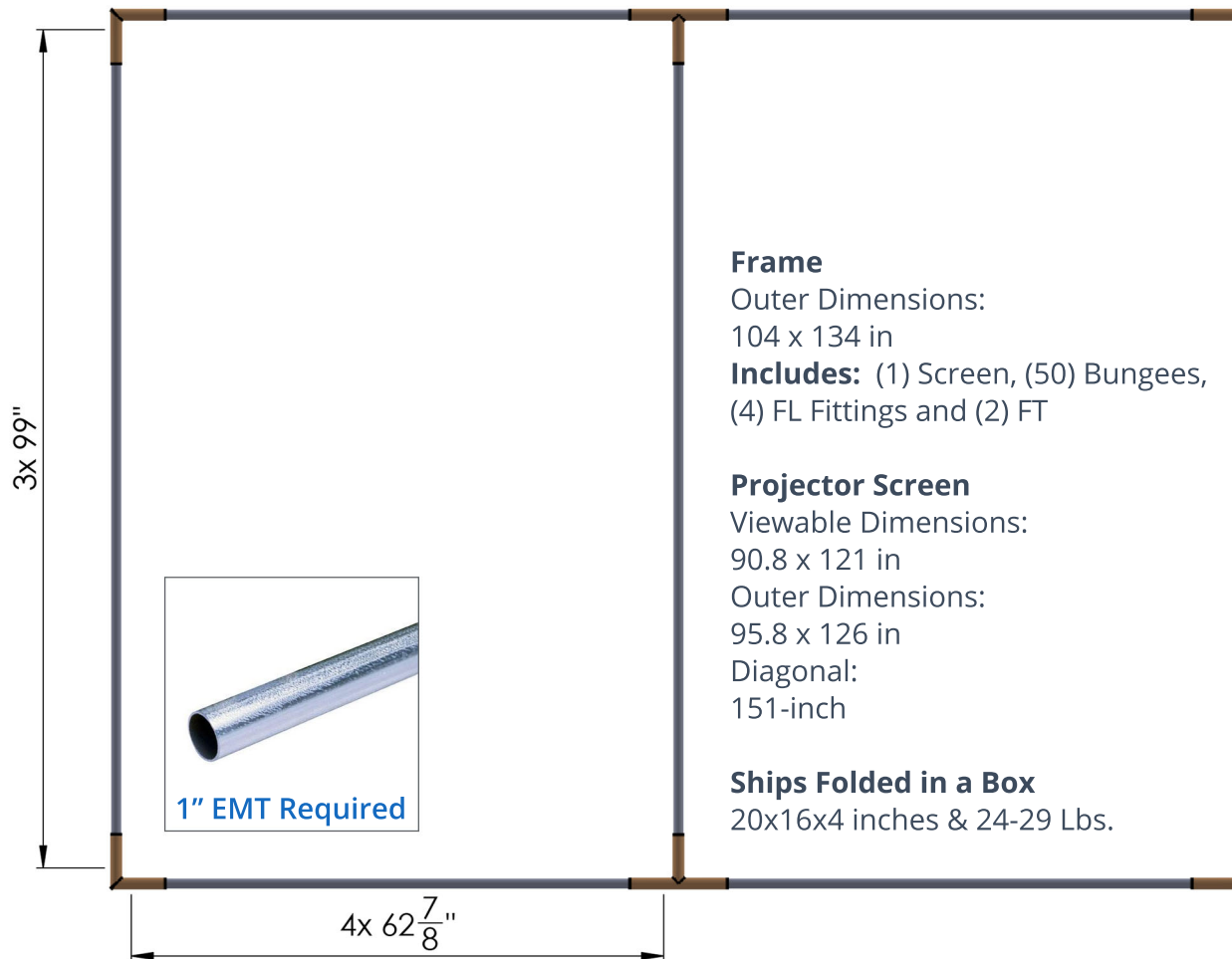

Tips:

1-inch (EMT) Electrical Metal Tubing /
Conduit Pipes – **Not included**

To achieve proper tension when
mounting your screen to your poles;
start by inserting the EMT pipe
4-inches into each corner fitting
provided, then push or pull the pipes
in or out of the fittings until you have
pulled the screen tight.

Attach the screen with the included
bungees. Insert the bungee cord
through the grommet hole from
behind the screen. The ball now
touches the backside of the black
vinyl border. Pull the cord over and
around the 1" EMT pole. Lastly, loop
the cord over the ball behind the
screen. Rotate top, bottom, left and
right— starting in the center and
work your way out to the corners.
Repeat until you have used every
grommet hole.

3 Easy Steps

1. Cut 1-inch EMT poles to the dimensions shown
2. Insert poles 4-inch into each corner/support fitting
3. Stretch the screen to the frame using the bungees