

Carl's Place

Carl's (4:3) 9x12 Ft -- 175in Diagonal Hanging DIY Projector Screen Kit (Portable)

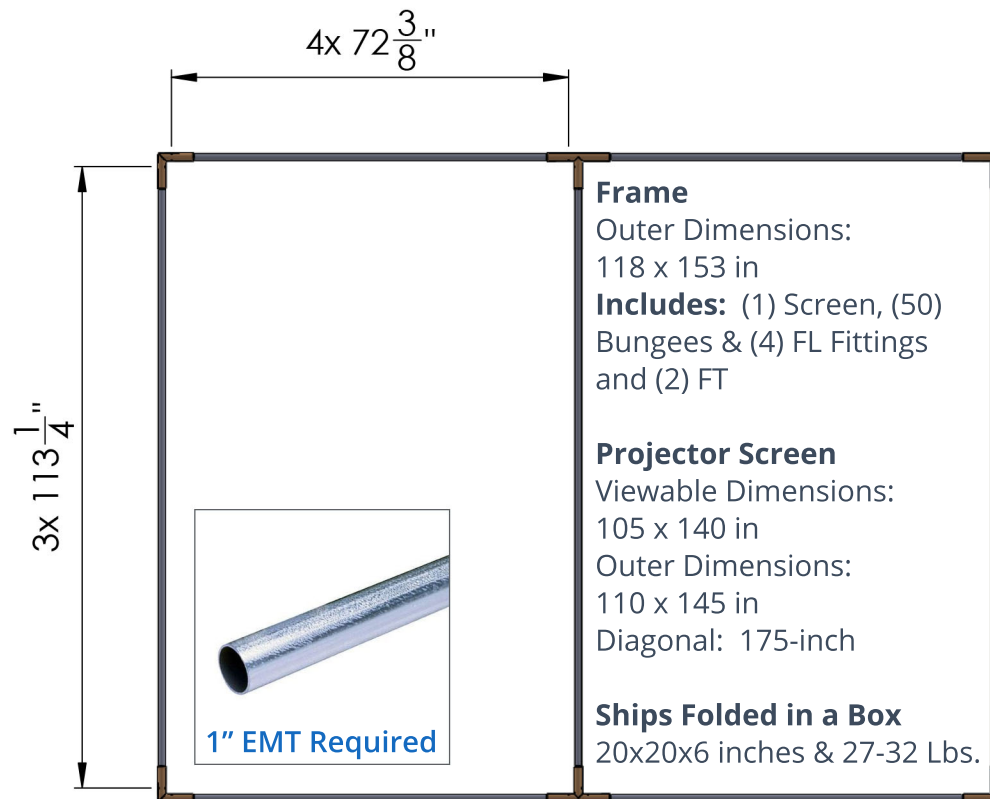

Tips:

1-inch (EMT) Electrical Metal Tubing / Conduit Pipes – **Not included**

To achieve proper tension when mounting your screen to your poles; start by inserting the EMT pipe 4-inches into each corner fitting provided, then push or pull the pipes in or out of the fittings until you have pulled the screen tight.

Attach the screen with the included bungees. Insert the bungee cord through the grommet hole from behind the screen. The ball now touches the backside of the black vinyl border. Pull the cord over and around the 1" EMT pole. Lastly, loop the cord over the ball behind the screen. Rotate top, bottom, left and right— starting in the center and work your way out to the corners. Repeat until you have used every grommet hole.

3 Easy Steps

1. Cut 1-inch EMT poles to the dimensions shown
2. Insert poles 4-inch into each corner/support fitting
3. Stretch the screen to the frame using the bungees